

Operating instructions

R 180



1	Introduction	3
2	Startup procedure	4
2.1	Location	4
2.2	Installation	4
2.2.1	Stand for coaxial Measuring systems	4
2.2.2	Stand for cone plate measuring systems	5
2.2.3	Rear view	6
2.2.4	Side view	7
3	The keypad	8
4	Settings	10
4.1	Language	10
4.2	Code for instrument settings and other measurement systems	10
4.2.1	Instrument settings	10
4.2.2	Other measurement systems	12
4.2.3	Baud rate	12
4.3	Status record	13
5	Measurements	13
5.1	Thermostating	13
5.2	Zero adjustment	13
5.3	Measurement mode HAND: Single point measurement without data storage	14
5.3.1	Procedure	14
5.3.2	Terminating a single point measurement	15
5.3.3	Time interval	15
5.3.4	Printing out data	16
5.4	Measurement mode AUTOMATIK: Step programs with data storage	16
5.4.1	Single point measurement with data storage	17
5.4.2	Procedure	17
5.4.3	Programs 3...9: changing shear rates	18
5.4.4	End of the measurement	19
5.4.5	Printing out data	19
5.4.6	Deleting measurement data	19
5.4.7	Data transfer	20
6	Appendix	20
6.1	Maintenance	20
6.1.1	Cleaning instrument parts	20
6.1.2	Calibrating and testing	21
6.2	Errors and malfunctions	22
6.3	Accessories	23
6.3.1	Standard accessories in case	23
6.3.2	Optional accessories	24
6.4	Technical data	25
6.4.1	Measurement head	25
6.4.2	Measurement systems following DIN standard 53 019	26
6.4.3	Relative measurement systems	26
6.4.4	Step programs	28
6.4.5	RS232 interface definition	28
6.4.6	Printer	28

1 Introduction

The proRheo R 180 is used for the simple determination of the viscosity of a wide range of substances in the lab or field. It is equipped with a rechargeable battery that allows it to be operated for approx. one hour at full load without connection to the power supply.

The proRheo R 180 is a rotational viscometer. Its open, concentric measurement system allows measurements by immersion. The measuring head and measuring tube are rigidly coupled; the measuring unit is driven by a direct-current motor.

A built-in microprocessor calculates the values for the viscosity with the aid of the measured torque, the set shear rate and the measurement system used. The sample temperature is measured by a Pt 100 sensor immersed in the substance.

The display shows you the following data:

- the sample temperature T in $^{\circ}\text{C}$,
- the torque M in $\text{mN}\cdot\text{m}$,
- the shear rate D in s^{-1} ,
- the shear stress τ (tau) in Pa ,
- the calculated viscosity η (eta) in $\text{Pa}\cdot\text{s}$,
- the measurement system, e.g. 11,
- the program step, e.g. 6 during an automatic step measurement.

The proRheo R 180 can store 50 measurements of step programs or single point measurements. An attached printer records the measurement data. With the aid of the rhesy 80 evaluation software, measurement data can be transferred to an attached computer and evaluated thus allowing the proRheo R 180 to be incorporated in computer-aided data acquisition systems. The rhesy 80 control and evaluation software allows you to perform computer-aided measurements.

2 Startup procedure

2.1 Location

In the lab, the stand with the proRheo R 180 should be positioned on a level bench with sufficient space for the peripherals that will be attached and a thermostat. The proRheo R 180 operates faultlessly in an ambient temperature range between + 10 and +40 °C.

2.2 Installation

2.2.1 Stand for coaxial Measuring systems

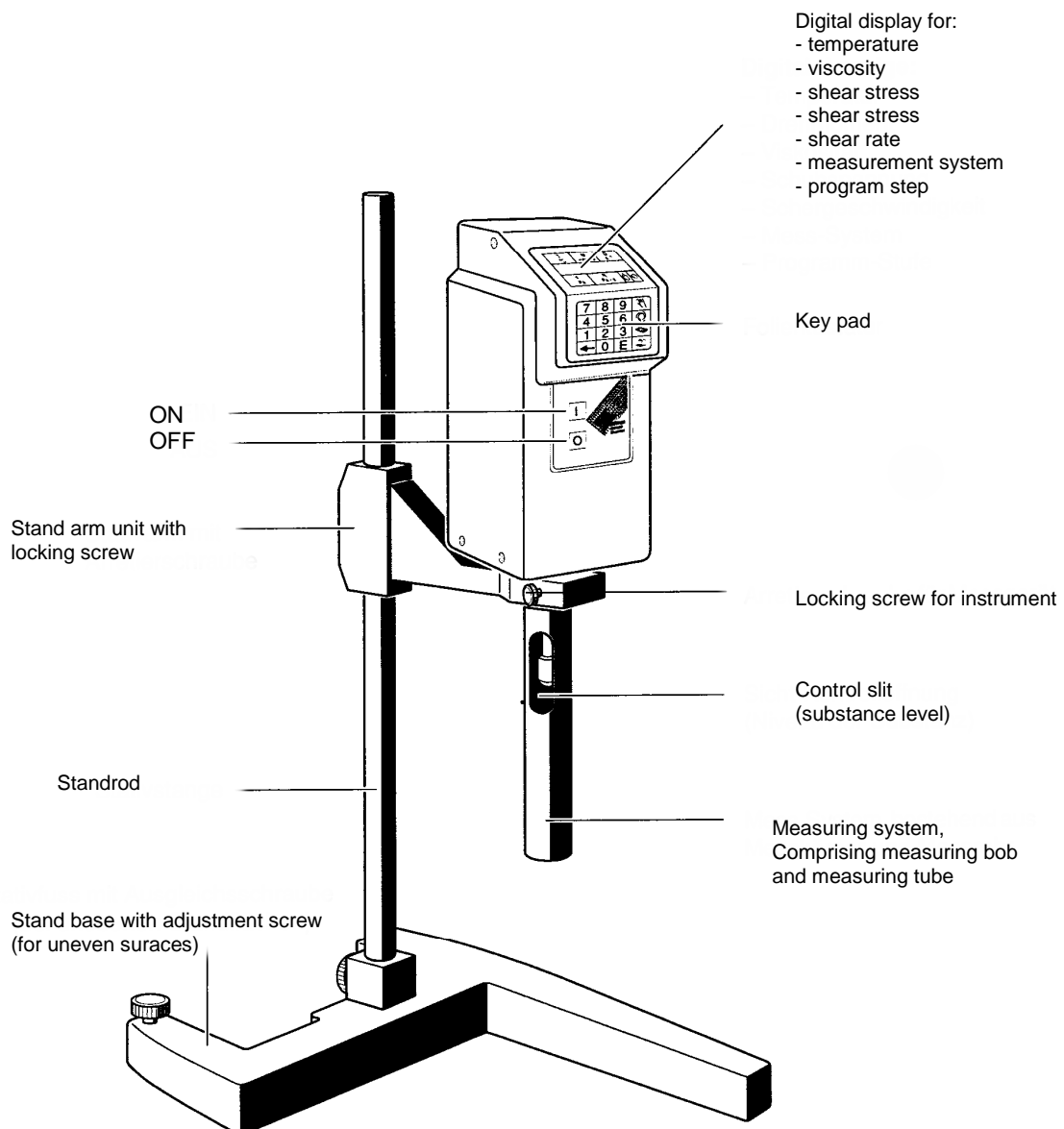

- Position stand rod in stand base and secure with the screw.
- Slide stand arm unit over stand rod and secure with the screw
- Install the proRheo R 180 and secure with the screw

2.2.2 Stand for cone plate measuring systems

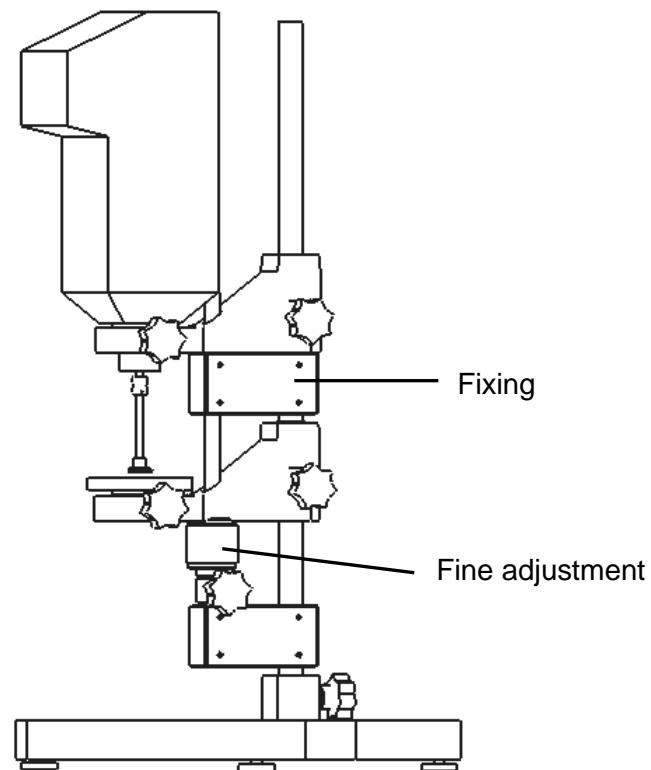

III. 3

1. Fix cone-plate measuring unit in stand foot as shown in III. 3.
2. Connect tubes of measuring plate for temperature with your cryostat.
3. Connect cable between temperature sensor of plate with external entry of cryostat.
4. Move stand arm to the top, set in the R 180 and fix measuring cone on the R 180.
5. Take off the white ring of the plate.
6. Loosen screw of the stand fixing of the plate and low down the plate.
7. Lower down carefully the R 180 on the fixing. A small gap has to rest between cone and plate. If not, please adjust fixing

8. Move plate up with the fine adjustment screw. Check with gauge that the gap between Tipp of the cone and plate is 0,05 mm.
9. Move up the R 180 with its stand arm and replace white ring of the plate.

2.2.3 Rear view

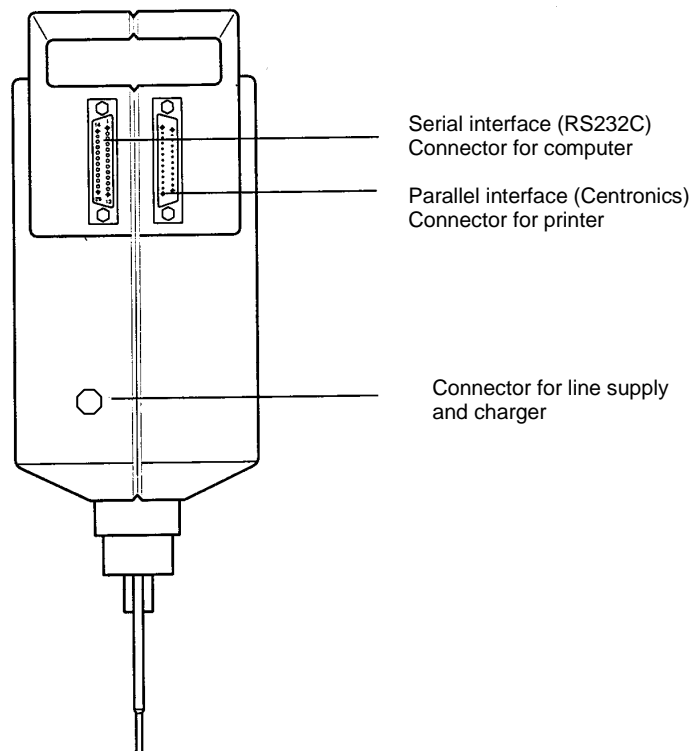

- Connect to the power supply
- Attach a printer as appropriate
- Attach a computer as appropriate

2.2.4 Side view

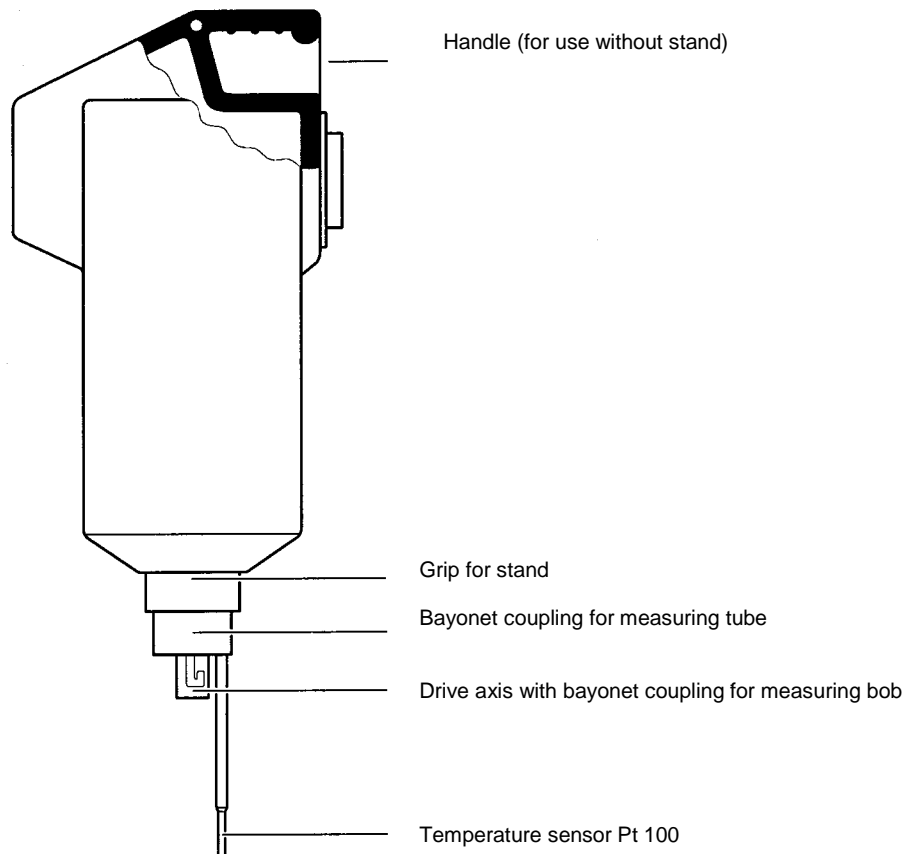

- Connect the measuring bob that you need for your first measurement to the drive axis.

Note: The higher the viscosity of the test sample, the smaller the measuring bob used (see sections 6.4.2 and 6.4.3).





- Push the measuring tube corresponding to the measuring system over the mounting and connect.





- Switch on the instrument. The display must show: proRheo R 180

followed by:

MEASURE MODE?
TEMPERATURE **. *.

3 The keypad

Keys	Entry	Function	
		During operation	Together with ON (I)
1 9	Numbers		
E	Confirm		
0 (Zero)	Number		Automatic zero adjustment
←	Delete	Terminates single point measurement (without data storage)	Deletes data of all measurement records
	• (Point)	Starting single point measurement (without data storage)	Select language E = 0, g = 1, f = 2, it = 3, sp = 4, hi = 5
	C (Letter)	Starting step programs	Select code Date = 1, Sample No. = 2, Density = 4, Time interval = 6, Quick measurement = 16, Other measurement sys. = 32
	B (Letter)	Prints out measurement records or a data line during single point measurement (without data storage)	Prints out status
	A (Letter)	Transfers data of all measurement records to the computer	

Key(s)	Function
Numbers	Entry of numeric values, code or program numbers.
E	Confirmation of an entry.
0 (zero)	Select Zero adjustment (see section 5.2) Simultaneously press this key when switching on: the display shows... 0 <...
←	<ul style="list-style-type: none"> • Delete data (see section 5.4.6) Simultaneously press this key when switching on: all data of stored measurements are deleted (display:...CLEAR.....) • With entry of letters/numbers, deletes from right to left. • Terminates the single point measurement in the measurement mode HAND.
Hand 	<ul style="list-style-type: none"> • Select language (see section 4.1) Simultaneously press this key when switching on: the display shows LANGUAGE. • Select single point measurement (without data storage): when MEASURE MODE? is shown on the display. • <8Decimal) point during the entry.
Automatic 	<ul style="list-style-type: none"> • Select code for instrument settings and own measurement systems (see section 4.2) Simultaneously press this key when switching on: the display shows CODE • Select step programs or single point measurement (with data storage) when MEASURE MODE? is shown on the display. • Letter C during the entry of a sample number.
Printer 	<ul style="list-style-type: none"> • Print out status (see section 4.3) • Simultaneously press this key when switching on: the instrument settings stored in the proRheo R 180 are printed. • Prints out a data line in the measurement mode HAND. • Prints out the stored measurement data. • Letter B during the entry of a sample number.
Computer 	<ul style="list-style-type: none"> • Transfers the measurement data after a step program. • Letter A during the entry of a sample number.

4 Settings

4.1 Language

When you switch the proRheo R 180 on for the first time, the display is in English. To ensure that the text appears in the language most appropriate to your needs, you are offered a choice of 6 languages. Exceptions are the words LANGUAGE, CODE, TRY AGAIN and CLEAR.

- Press the hand key and at the same time switch the instrument on:
LANGUAGE: appears on the display.

Enter one of the following numbers for your language:

- | | | | |
|-----|----------|-----|------------|
| ▪ 0 | English | ▪ 1 | Deutsch |
| ▪ 2 | Francais | ▪ 3 | Italiano |
| ▪ 4 | Espanol | ▪ 5 | Nederlands |

- Press the E key to confirm the entry.

Your language is stored by the proRheo R 180 until you define a different one.

4.2 Code for instrument settings and other measurement systems

4.2.1 Instrument settings

With the entry of a code, you can set the following features of the proRheo R 180. The proRheo R 180 stores the corresponding configuration until you define a new code.

Record **date** (sub-code 1):

Each measurement is recorded with a date.

The stored date is displayed before every measurement.

- If it is current, you can confirm with **E**, otherwise you must first overwrite it with the current date (max. 8 digits).

Note: To enable the evaluation software to recognize entry of the date, you must enter it in the format xx.yy.zz.

Record **sample number** (sub-code 2):

Each measurement is recorded with a sample number.

Entry of a sample number is requested before every measurement; input format: max. 16 characters.

Calculate kinematic viscosity (sub-code 4):

In each measurement the measured dynamic viscosity is divided by the inputted density to calculate the kinematic viscosity; this is displayed and recorded.

Entry of the density is requested before every measurement.

The kinematic viscosity ν (ny) is the quotient of the dynamic viscosity η (eta) and the density ρ (rho): $\nu = \eta / \rho$

Note: The density ρ (rho) is entered in g/mL. The calculated kinematic viscosity ν (nu) appears in the display field of η (eta) and has the unit $10^{-3} \text{ m}^2/\text{s}$. Its value is also printed out in the unit $10^{-3} \text{ m}^2/\text{s}$ in the VISCOSITY column.

Calculation of the kinematic viscosity is meaningful only if the dynamic viscosity is absolute (measurement with DIN measurement systems).

Time interval measurement (sub-code 8):

In the HAND measurement mode (single point measurement without data storage) the values remain in the display for the inputted time interval (stopwatch function). If a printer is attached, the current viscosity is printed out in accordance with the time interval. This allows you to determine the viscosity as a function of time, e.g. with thixotropic or reactive samples.

Before every measurement, the stored time interval is displayed and you can either confirm it with **E** or overwrite it.

Quick single point measurement (sub-code 16):

In the HAND measurement mode (single point measurement without data storage), the torque is measured for approx. 1 second at all shear rates.

If measured values determined in this manner are not sufficiently stable at low rotational speeds, you should not set sub-code 16; in such a case the measurements last longer at a lower shear rate ($D < 80 \text{ s}^{-1}$), e.g. approx. at $D = 6,5 \text{ s}^{-1}$.

You can determine the instrument settings by entry of a code comprising the **sum** of the respective sub-codes.

- Press the automatic key and at the same time switch on the instrument.
CODE: appears on the display.

- 0 None of the instrument settings active
- 1 Date
- 2 Sample number
- 4 Density
- 8 Time interval in s for single point measurements
- 16 Quick single point measurement

Baud rate:

- Enter 2400, 4800 or 9600 confirm with **E**.

4.3 Status record

You can have a printout of the language, instrument settings, your own measurement systems with the appropriate conversion factors and the step programs 3...9 with the appropriate shear rates (see section 6.3) that are stored in the proRheo R 180.

- Press the printer key and at the same time switch the instrument on: you obtain the status record.

Note: a. The "+" and "-" signs under the code number show which sub-codes have been selected: "+" = selected, "-" = not selected.

b. Measurement systems with kD and $k\tau = 0$ have not been programmed.

5 Measurements

5.1 Thermostating

You can use a commercial thermostat for thermostating.

- Close the measuring tubes with the caps and then immerse as far as possible in the thermostat bath ensuring that the thermostating medium can not splash into the substance.

The fill level of the measurement system should be as high as possible so that the temperature sensor is deeply immersed in the substance. Inside of the measuring tubes a filling mark (small groove) indicates the filling volume for a DIN measurement system without the measuring bob (take into account the thermal expansion of the thermostating medium and of the substances being measured).

With temperatures above 50 °C, you should take into consideration the heat losses due to air circulation around the measurement system as well as condensation. We advise covering the top of the thermostat bath around the measuring tube.

5.2 Zero adjustment

You should perform a zero adjustment with the measurement system in the absence of sample every day and after each change of the measurement system. The zero adjustment must be done under the same operating status as the following measurements. (Batterie or power supply operation).

- Press the key 0 (zero) and simultaneously switch on the proRheo R 180.
As long as the instrument executes the zero adjustment, the display shows

...> 0 <...

Then the following appears: MEASURE MODE?
TEMPERATURE **.*

- Note:** a. The zero adjustment is stored.
b. Whenever possible, you should perform the zero adjustment after the instrument has warmed up. Allow the proRheo R 180 to run at a shear rate of 50 s^{-1} for approx. 30 s.

Caution: With an empty measurement system, the proRheo R 180 should not rotate faster than $D = 200 \text{ s}^{-1}$

5.3 Measurement mode HAND: Single point measurement without data storage

Select this type of measurement if you wish to determine the viscosity of the sample at **one** shear rate.

The proRheo R 180 does **not store** the measured data of this measurement mode! To store single point measurements, you must perform these under the AUTOMATIC measurement mode (see section 5.4.1).

5.3.1 Procedure

- Immerse measurement system without cap in the sample or add the sample to the closed measurement system (fill volume: see section 6.4.2).
- Switch the proRheo R 180 on and wait until the display shows: MEASURE MODE?
TEMPERATURE*.*

Note: If you have to thermostat the sample, wait until the desired temperature is displayed before starting the measurement (see section 6.4).

- Press the hand key.
- Enter the measurement system and confirm with **E**.
- Enter the values/designation of the subsequent instrument settings that you have selected (see section 5.1) and confirm with **E** in each case.

Note: If you confirm DENSITY with **E** without entering a value, the message TRY AGAIN appears.

SHEAR RATE:

- Enter a value appropriate to the sample and confirm with **E**.

Note: a. The values/numbers for interval, measurement system and shear rate are stored, so that for the next measurement you can either confirm these with **E** or enter new values/numbers.

b. The shear rate range is 6.5...1291 s⁻¹ for the DIN measurement systems 11, 22 and 33 (for other measurement systems, see section 6.4.2). If you enter a number outside this range, SHEAR RATE immediately reappears on the display to allow the "correct" value to be entered.

The measurement starts. You are shown the following data on the display after approx. 5 s:

- the sample temperature T in °C
- the torque M in mN.m
- the shear rate D in s⁻¹
- the shear stress τ in Pa
- the calculated viscosity η in Pa.s
- the measurement system, e.g. 11.

The proRheo R 180 acquires several measured values per second and displays the recalculated mean values.

During the measurement you can change the shear rate:

- Press one of the numeric keys (1 to 9): SHEAR RATE appears in the display.
- Enter new value and confirm with **E**.

Note: If the torque is too large (>10 mNm), you are shown the message: M TOO HIGH (M = torque). In operation with the power supply unit, the proRheo R 180 switches itself off at a torque of approx. 11 mNm (see section 8).

You can either enter a lower value for the shear rate or, if possible, use a more suitable measurement system.

If the torque is too low (<0,25 mNm), you are shown the message: M TOO LOW. In this case you can enter a larger value for the shear rate or use a more suitable measurement system (see sections 6.4.2 or 6.4.3).

5.3.2 Terminating a single point measurement

To terminate a single point measurement, either

- press the arrow key or
- switch off the instrument.

5.3.3 Time interval

If you have attached a printer, the recalculated viscosity is printed out.

Note: a. The time intervals outputted by the printer do not always coincide with the inputted value owing to rounding and the time response.

b. With low shear rates, the measurement time can be larger than the inputted time interval. If this interferes: Select quick single point measurement as an instrument setting (sub-code 16, see section 4.2.1).

c. If no printer is attached, the display stops after the interval time has elapsed until you switch the instrument off or attach a printer (stopwatch function).

5.3.4 Printing out data

If you have attached a printer and have selected INTERVAL, the data are printed out online (see section 4.2). The instrument settings you have selected and whose value you have entered are printed out as a title. Exceptions are the titles DATE and SAMPLE NO., which are always printed out.

If you have not selected INTERVAL or have entered **0** (zero) as its value, you can press the printer key during the measurement: the data currently displayed are printed out.

5.4 Measurement mode AUTOMATIK: Step programs with data storage

Select this measurement mode if you wish to use step programs to measure the viscosity of the sample at several shear rates. The samples are automatically measured at 8 different shear rates and the results are stored. You can use the resulting data to plot a flow curve to characterize the sample.

As a special case, you can perform single point measurements in this measurement mode to store your data (see below).

You have a choice of 10 programs:

Program	Definition
0	You can enter the lowest and highest shear rate (D MIN, D MAX). The proRheo R 180 calculates the linear intermediate steps. D MIN and D MAX of program 0 are not stored , but the results are. You can use this program for rapid scanning of a shear rate range to determine the suitable D MIN/ D MAX values for further measurements.
1	Measurement is performed at rotational speeds between 50...1000 min ⁻¹ in geometric steps (see section 6.4.4). You can not change this program.
2	Measurement is performed at rotational speeds between 5...100 min ⁻¹ in geometric steps (see section 6.4.4). You can not change this program.
3 - 9	You can enter the lowest and highest shear rate (D MIN, D MAX) for 7 programs. (D MIN, D MAX) remain stored for every program. The proRheo R 180 calculates the linear or geometric intermediate steps in each case. You can change and print out these programs (see sections 5.4.3).

5.4.1 Single point measurement with data storage

If you enter the value 0 (zero) for D MAX in the step programs 0 or 3...9, a single point measurement with data storage follows.

The measurement is performed with a shear rate $D = D \text{ MIN}$. The measurement time is 15 s with the mean value being calculated from the measurements during the last 10 s.

5.4.2 Procedure

- Immerse measurement system without cap in the sample or add the sample to the closed measurement system.
- Switch the proRheo R 180 on and wait until the display shows:

MEASURE MODE?
TEMPERATURE **. *

Note: If you have to thermostat the sample, wait until the desired temperature is displayed before starting the measurement (see section 6.4).

- Press the automatic key.
- Enter the measurement system and confirm with **E**.
- Enter the values/designation of the subsequent instrument settings that you have selected (see section 4.2.1) and confirm with **E** in each case.

Note:

- a. If you confirm DENSITY with **E** without entering a value, the message TRY AGAIN appears.
- b. The measurement system remains stored so that for the next measurement you either can confirm it with **E** or enter a new number.

PROGRAM No.:

- Enter the desired number and confirm with **E**.
If you have selected program 1...9, the proRheo R 180 immediately starts the measurement. If you have entered **0**, the display shows:
DMIN:
- Enter the initial shear rate and confirm with **E**.
D MAX:
- Enter the final shear rate and confirm with **E**.

Note:

- a. If no shear rates have been entered for the programs 3...9 the display shows D MIN followed by D MAX.
- b. The shear rate range is $6.5 \dots 1291 \text{ s}^{-1}$ for the DIN measurement systems 11, 22 and 33 (for other measurement systems, see section 6.4.3). If you enter a number outside this range, D MIN or D MAX immediately reappears on the display to allow the "correct" value to be entered.
- c. If you enter a value for D MAX that is less than that of D MIN, the proRheo R 180 first acquires the 8 measurement points in descending then in ascending order.

- d. With $D_{MAX} = D_{MIN}$, the 15 measurement points are acquired at the same shear rate.
- e. With $D_{MAX} = 0$ the proRheo R 180 performs a single point measurement.

The display shows PLEASE WAIT for approx. 5 s before the measured value appears.

You can then view the following data:

- the sample temperature T in $^{\circ}\text{C}$
- the torque M in $\text{mN}\cdot\text{m}$
- the shear rate D in s^{-1}
- the shear stress τ in Pa
- the calculated viscosity η in $\text{Pa}\cdot\text{s}$
- the measurement system, e.g. 11
- the program step, e.g. 6.

The R 180 acquires several measured values per second and displays the recalculated mean values. The measurement time for a step is 10 s. The proRheo R 180 stores the mean of the calculated values for every step in each case. Before every step the message PLEASE WAIT is displayed for approx. 5 s. During this time, the proRheo R 180 acquires no measured values.

Note:

- a. If the torque is too large ($>7.5 \text{ mNm}$), you are shown the message: M TOO HIGH ($M = \text{torque}$). In operation with the power supply unit, the proRheo R 180 switches itself off at a torque of approx. 11 mNm .
You can either enter a lower value for D_{MAX} or D_{MIN} or, if possible, use a more suitable measurement system.
- b. If the torque is too high during the measurement, the proRheo R 180 automatically returns to the step preceding that which it has just reached, in other words instead of 8 steps it performs, e.g. 6.
- c. If the torque is too low ($<0,25 \text{ mN}\cdot\text{m}$), you are shown the message: M TOO LOW. In this case you can enter a larger value for the shear rate or use a more suitable measurement system. (see sections 6.4.2 or 6.4.3).

5.4.3 Programs 3...9: changing shear rates

If you wish to change the shear rates of one of the programs, when PROGRAM No. is displayed you must enter the appropriate number

- **three times**, e.g. 444 (you can not see the last number),
- confirm with **E**,
- enter the new value of D_{MIN} then that of D_{MAX} and confirm with **E**:
The new values are stored and the proRheo R 180 starts the measurement.

5.4.4 End of the measurement

When the measurement is at an end, the display shows:

```
MEMORY FREE: 23 (example)
READY
```

The proRheo R 180 can store the data of 50 step programs or single point measurements.

To start the next measurement immediately, press any key (except the printer key). The display shows:

```
MEASURE MODE?
TEMPERATURE **.*
```

5.4.5 Printing out data

In the AUTOMATIC measurement mode, the data of step programs and single point measurements are not printed out online.

- On completion of a measurement (or after the instrument has been switched on), press the printer key. The proRheo R 180 immediately starts with the printout of the **last** measurement and the display shows:
26 (example)
<E> ALL RECORDS
26 = number of measurements not yet printed out.
- If you wish to have the data of all measurements that are not yet printed out, press the **E** key: The proRheo R 180 continues the printout until the first stored measurement.
- If you wish to print out the measurement before last, press the printer key: The measurement before last is printed out; the display shows the number of measurements not yet printed out. You can repeat this procedure until the data of all measurements have been printed out.
- To start the next measurement, press any key (except the printer or **E** key). On the display appears:
MEASURE MODE?
TEMPERATURE **.*

5.4.6 Deleting measurement data

To delete the stored data of all measurements, proceed as follows:

- switch off the proRheo R 180.
- Press the arrow key and simultaneously switch it back on: during the clearing of all measurement data, the display shows: ---CLEAR---

5.4.7 Data transfer

You can transfer the measurement data if you have loaded the Rhesy A evaluation software or the Rhesy S control and evaluation software on your computer. If you press the computer key at the end of every measurement, the data are transferred.

After the data have been transferred, the display shows: MEASURE MODE?
TEMPERATURE *.*

in other words, you can start the next measurement.

Note: If, after several measurements, you transfer the data of the last measurement, the data of all measurements stored up to this point are always transferred. If you switch off the proRheo R 180 and press the computer key after switching it back on, once again all stored measurements are transferred.

To avoid this, you must delete the stored data before starting a new measurement:

- Switch off the proRheo R 180.
- Press the arrow key and simultaneously switch it back on: during the clearing of all measurement data, the display shows: ---CLEAR---

6 Appendix

6.1 Maintenance

Warning: The proRheo R 180 and the power supply may be opened only by qualified service engineers!

6.1.1 Cleaning instrument parts

- If the measuring head, drive shaft coupling or stand are really dirty or badly contaminated, clean only with a cloth moistened with soapy water, gasoline or alcohol.
- To clean the measuring head and measuring tube, always uncouple these from the proRheo R 180!
- You can use appropriate solvents for the measurement systems.
- Never place the O-rings of the caps in organic solvents! Lightly grease them with silicone grease.
O-rings material: NBR/butadiene-acrylonitrile elastomer
Internal diameter/cord thickness: 26/3 mm, 20/3 mm, 9/3 mm

6.1.2 Calibrating and testing

The proRheo R 180 can be calibrated only by proRheo service. Special instruments and specialized knowledge are required.

To test whether the instrument is measuring properly and/or proper measurements have been performed, you can use calibration oils for viscosity measurements.

Another possibility is to measure a suitable substance with the proRheo R 180 after purchase or a calibration and test the instrument with the same substance at regular intervals under identical measurement conditions (particularly at the same temperature). You should obtain the same result. This method allows you to determine whether the instrument has undergone any change.

- Suitable substances are those whose viscosity behavior does not change over a lengthy period of time (e.g. motor oils, silicon oil, paraffin). You should keep ample quantities of such an oil on stock and use it only **once** for the measurement; in other words, do not pour the substance back in the bottle on completion of the measurement!
- Substances exhibiting Newtonian behavior are preferable (there should be a straight line between several measurement points and the zero point). Glycerol (hygroscopic) and water (viscosity too low) are unsuitable.

6.2 Errors and malfunctions

Error / malfunction	Reason	Action
The lamp of the power supply unit does not light up	- Not attached to power supply or power supply defective	Check power supply Call proRheo Service
The display shows › READY	- The entries are wrong or not stored correctly - Internal buffer battery is discharged	Switch off the R 180 and simultaneously press the hand key. Reselect or reenter language and code Call ProRheo service
The proRheo R 180 switches itself off	- The battery is discharged (battery operation only) - Battery faulty - Power supply unit disconnected from power supply - Torque too high (with single point measurement) - Torque too high (with step program)*	Attach the R180 to the power supply and charge battery Call proRheo service (instrument can be operated using power supply) Attach to the power supply On restart, either enter lower value for shear rate or select a smaller measurement system On restart, enter lower value for D MAX

* After an increase in the speed (shear rate), a test is first performed to check that the torque is lower than 10 mNm. If it is higher, all later steps are skipped. If, however, e.g. in step 6 a torque of 10 mNm is almost reached, the next speed is tested. If the difference between the steps is large, the torque can be so high that the instrument switches itself off in operation with the power supply unit or when the battery is almost completely discharged.

6.3 Accessories

6.3.1 Standard accessories in case

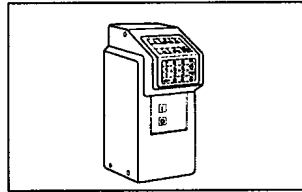

Measuring instrument

Order No.

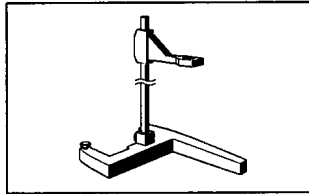

Stand, comprising

- Stand base with adjustment screw
- Stand rod
- Stand arm with locking screw

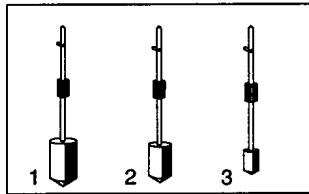

Measurement system of stainless steel, comprising:

- | | |
|---------------------------------------|--------|
| Measuring bob 1 (Ø 30 mm, l = 45 mm) | 112820 |
| Measuring bob 2 (Ø 24 mm, l = 36 mm) | 112821 |
| Measuring bob 3 (Ø 14 mm, l = 216 mm) | 112822 |

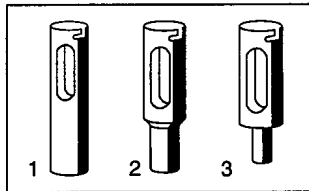

- | | |
|-------------------------------|--------|
| Measuring tube 1 (Ø 32,54 mm) | 112932 |
| Measuring tube 2 (Ø 26,03 mm) | 112937 |
| Measuring tube 3 (Ø 15,8 mm) | 112938 |

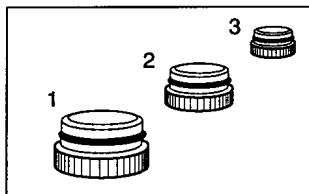

- | | |
|------------------------------|--------|
| Cap 1 (for measuring tube 1) | 112872 |
| Cap 2 (for measuring tube 2) | 112877 |
| Cap 3 (for measuring tube 3) | 112878 |

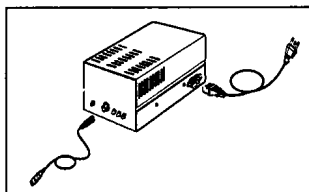

Power supply

6.3.2 Optional accessories

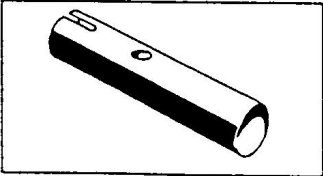
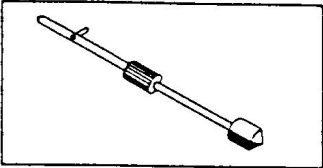
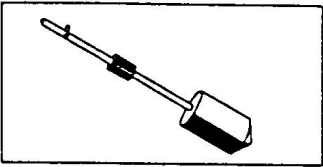
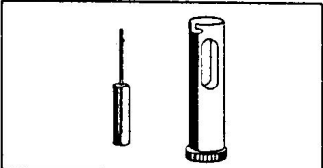
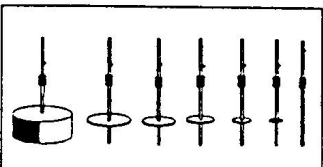
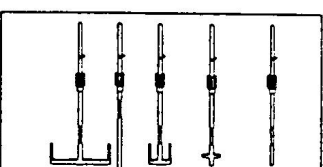
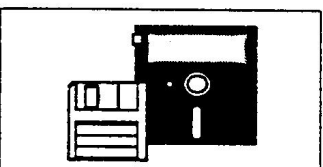
		Order No.
	Measuring tube of aluminium set of 100	111 931
	Measuring bob No. 4 (\varnothing 14mm, l = 10,5mm) for high viscosities	111 906
	Measuring bob No. 9 (\varnothing 31,5mm, l = 45mm) for high shear rates and low viscosities (forms with measuring tube 1 measuring system 19)	111 875
	Double slit system MS 0 for low viscosities	112 823
	Measurement systems ISO 2555 (set)	111 948
	Measurement system TV (set)	111 949
	Software Rhesy 180 A	4000608
	Software Rhesy 180 S	4000610
	Cable RS 232	4010920
	Cable USB	4010922

6.4 Technical data

6.4.1 Measurement head

Measurement principle	Rotational viscosimeter with cylindrical measurement
Rotational speed	
• Range	5 to 1000 min ⁻¹
• Accuracy :	± 0,5% of inputted set value
Torque range	0,25 to 10,0 mN·m
Temperature	
• Recording	Pt100 sensor
• Range	0 to 120°C
• Resolution	0,2 °C
Admissible ambient temperature	+10 to +40 °C
Battery capacity	1 hour with full load operation
Data memory	Lithium battery, lifetime min. 3 years
Data output	
• Printer	Parallel interface (Centronics)
• Computer	Serial interface (RS232) or USB
Dimensions (measuring instrument)	
• Width x depth x height	105 x 135 x 350 mm
• Weight	2,2 kg
Power supply unit	
• Voltage/Current	100 - 120 V±10% / approx. 320 mA and 220 - 240 V±10% / approx. 160 mA
• Frequency	50 - 60 Hz
• Type of protection	I
• Approvals	Europe EN 60950 Electrical safety EN 55022 Interference suppression Canada CSA 22.2 No. 151-M1986

6.4.2 Measurement systems following DIN standard 53 019

System No.	Tube Ø mm No.	Bob Ø mm No.	Shear Rate [s ⁻¹]	Viscosity [Pa·s]	Fill volume [ml]
11	32,54 1	30 1	6,5 – 1291	0,005 – 19	Ca. 24
22	26,03 2	24 2	6,5 – 1291	0,010 – 38	Ca. 16
33	15,18 3	14 3	6,5 - 1291	0,050 – 191	Ca. 9
19	32,54	31,5 9	16,1 – 3230	0,002 – 7	Ca. 18

Double slit measurement system following DIN standard 54 453

System	Tube Ø mm	Bob Ø mm.	Shear rate [s ⁻¹]	Viscosity [Pa·s]	Fill volume [ml]
50	28 32,54	25,81 30	6,5 – 1291	0,001 – 5	Ca. 38

6.4.3 Relative measurement systems

Measuring bob 2, 3 and 4 with measuring tube 1

System	Tube Ø mm No.	Bob Ø mm No.	Shear rate [s ⁻¹]	Viscosity* [Pa·s]
12	32,54 1	24 2	1,7 -354	0,027 – 104
13	32,54 1	14 3	0,8 – 152	0,210 – 800
14	32,54 1	14 4	0,8 - 152	0,545 – 2.080

* These viscosity ranges are measured and are just approximate!

Mesuring bob 1,2,3 and 4 without measuring tube

Rotational speed range: 5 to 1000 min⁻¹

System no.	Bob no.	Viscosity [Pa·s]
1	1	0,020 – 76
2	2	0,048 – 182
3	3	0,340 – 1.292
4	4	0,550 – 2.090

With these systems the speed **n** is shown instead of the shear rate **D**.

Measurement systems following ISO standard 2555

Rotational speed range: 5 to 1000 min⁻¹

System no.	Bob no.	Viscosity [Pa·s]
61	1	0,007 – 26
62	2	0,028 – 106
63	3	0,070 – 264
64	4	0,139 – 529
65	5	0,278 – 1.057
66	6	0,696 – 2.643
67	7	2,783 – 10.574

With these systems the speed **n** is shown instead of the shear rate **D**.

Measurement systems TV

Rotational speed range: 5 to 1000 min⁻¹

System no.	Bob no.	Viscosity [Pa·s]
71	1	0,003 – 10
72	2	0,027 - 104
73	3	0,160 - 605
74	4	0,665 – 2.530
75	5	2,580 – 9.800

With these systems the speed **n** is shown instead of the shear rate **D**.

6.4.4 Step programs

Step - Program 1

Rotational speed step	D [s ⁻¹]	n [min ⁻¹]
1	64,6	50
2	99,0	76,7
3	152	118
4	233	181
5	357	277
6	549	425
7	841	652
8	1291	1000

Step - Program 2

Rotational speed step	D [s ⁻¹]	n [min ⁻¹]
1	6,46	5,0
2	9,90	7,67
3	15,2	11,8
4	23,3	18,1
5	35,7	27,7
6	54,,9	42,5
7	84,1	65,2
8	129	100

--	--	--

6.4.5 RS232 interface definition

The following settings apply for the RS232 interface

- Baud rate: 2400 to 9600 baud (see section 4.2.3)
- Data bits: 8
- Stop bits: 1
- Parity: none
- Mode: full duplex

Connector (DB, 25 pin, male)

Pin-Number	Signal direction	Designation	Function
2	Output	TxD	Transmit Data
3	Input	RxD	Receive Data
7	-	SGND	Signal Ground

6.4.6 Printer

Attachment via parallel interface (Centronics).

You can attach a printer using a normal printer cable (25 pin, male, Centronics).

Character set setting:

- USA or GB
- IBM emulation